

FRONT VIEW

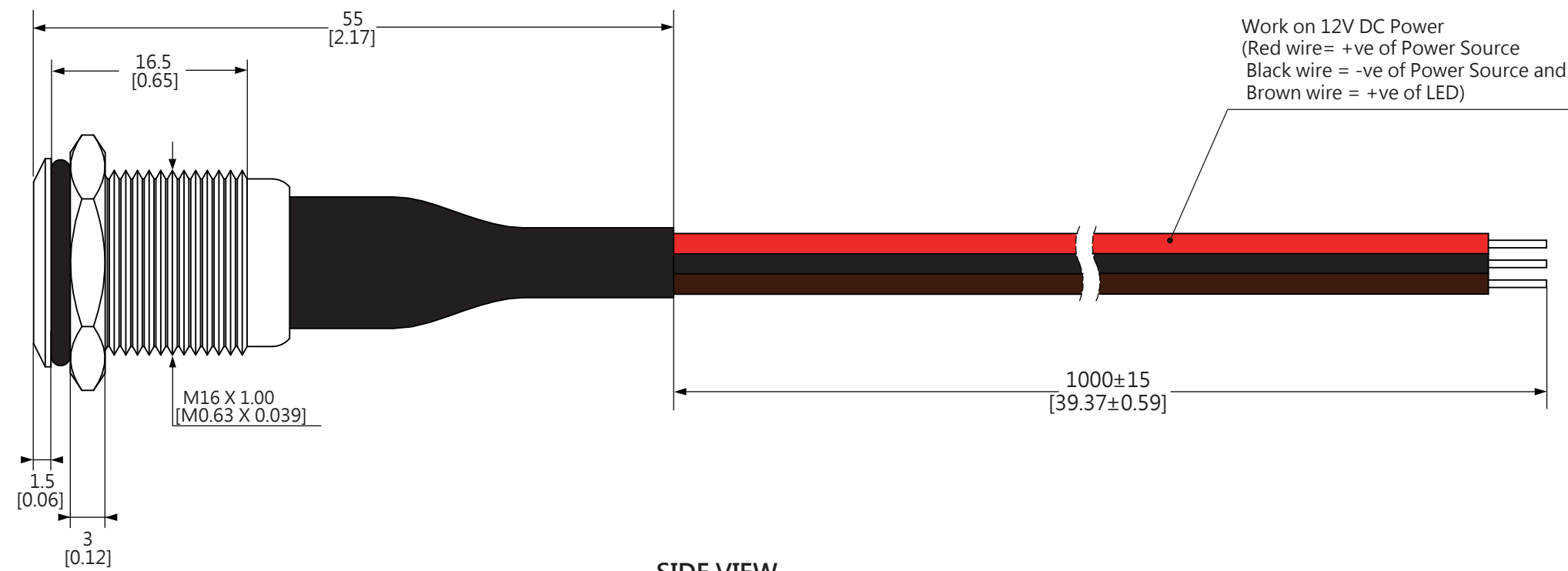

SIDE VIEW

Work on 12V DC Power
 (Red wire= +ve of Power Source
 Black wire = -ve of Power Source and
 Brown wire = +ve of LED)

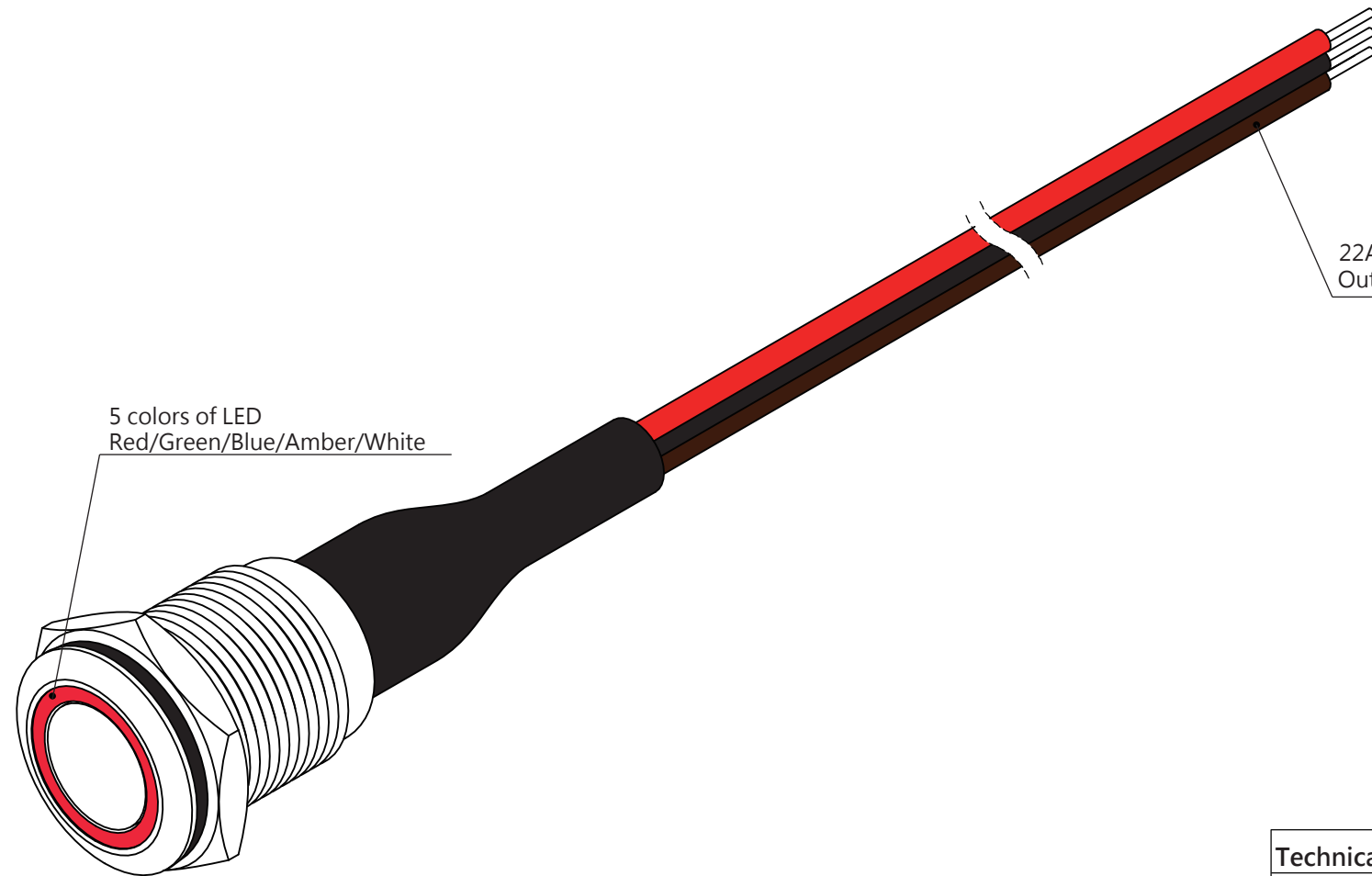

ISOMETRIC VIEW

22AWG Red/Black/Brown Wire
 Outer Diameter is 1.6 [0.06]

5 colors of LED
 Red/Green/Blue/Amber/White

All dimensions in millimeters [Inches]

Technical Information (Per module):			
Operating Voltage: DC 12V			
Maximum Current Load: 3A		PRODUCT NAME: Anti-Vandal Switch	
Net Weight: 32g for Silver Housing, 25g for Black Housing		VERSION: 16mm diameter	
PRODUCT NUMBER: 371	REVISION: A	PAGE: 1 of 3	

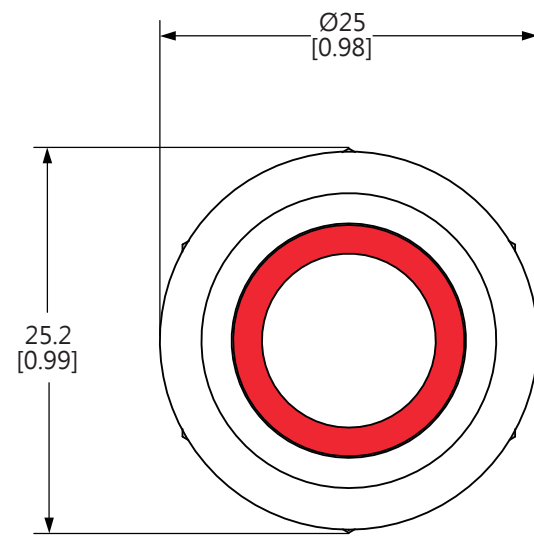

FRONT VIEW

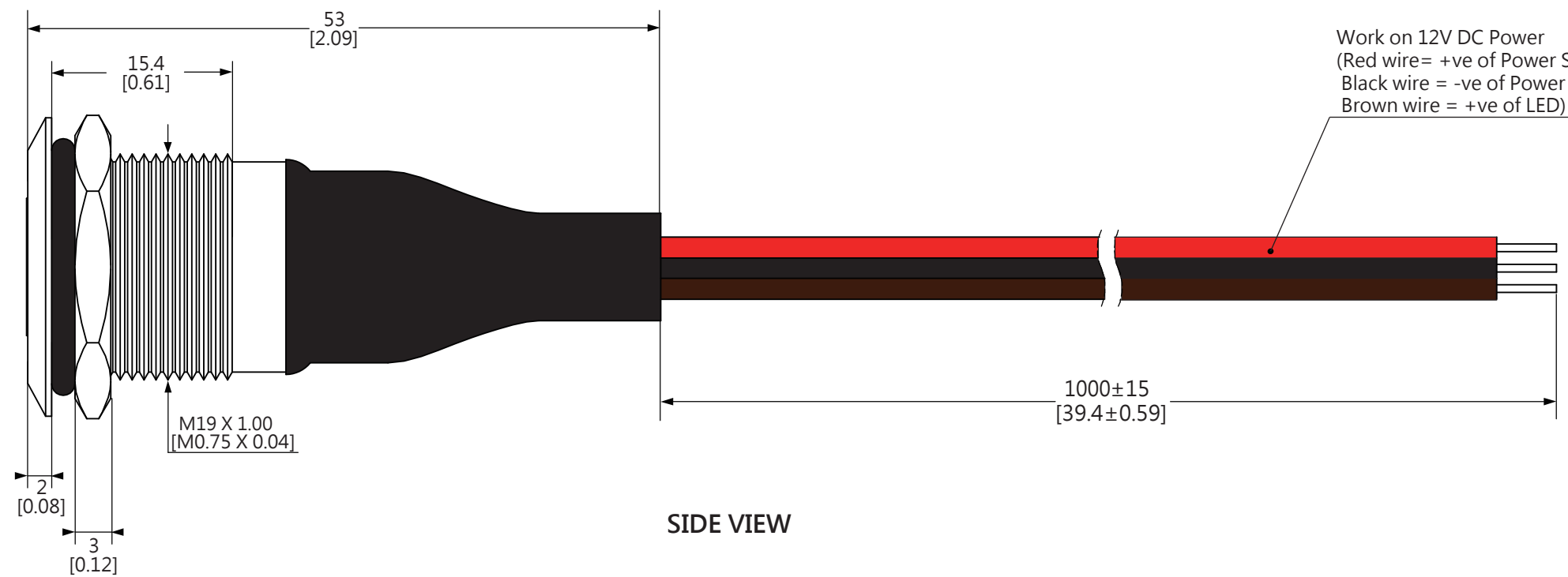

SIDE VIEW

Work on 12V DC Power
 (Red wire = +ve of Power Source
 Black wire = -ve of Power Source and
 Brown wire = +ve of LED)

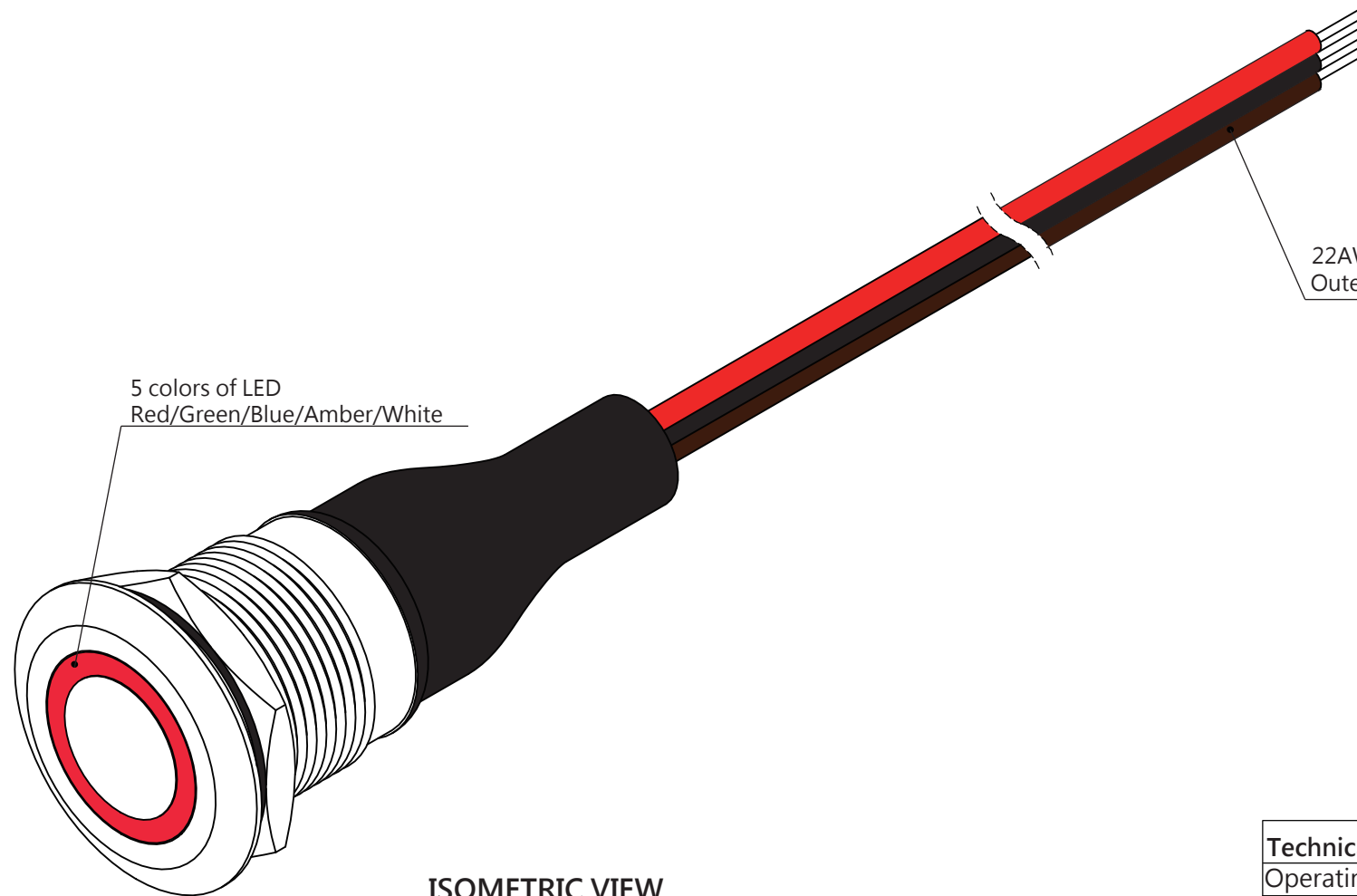

ISOMETRIC VIEW

22AWG Red/Black/Brown Wire
 Outer Diameter is $\varnothing 1.6$ [0.06]

5 colors of LED
 Red/Green/Blue/Amber/White

All dimensions in millimeters [Inches]

Technical Information (Per module):			
Operating Voltage: DC 12V			
Maximum Current Load: 3A		PRODUCT NAME: Anti-Vandal Switch	
Net Weight: 37g for Silver Housing, 29g for Black Housing		VERSION: 25mm diameter	
PRODUCT NUMBER: 371	REVISION: A	PAGE: 2 of 3	

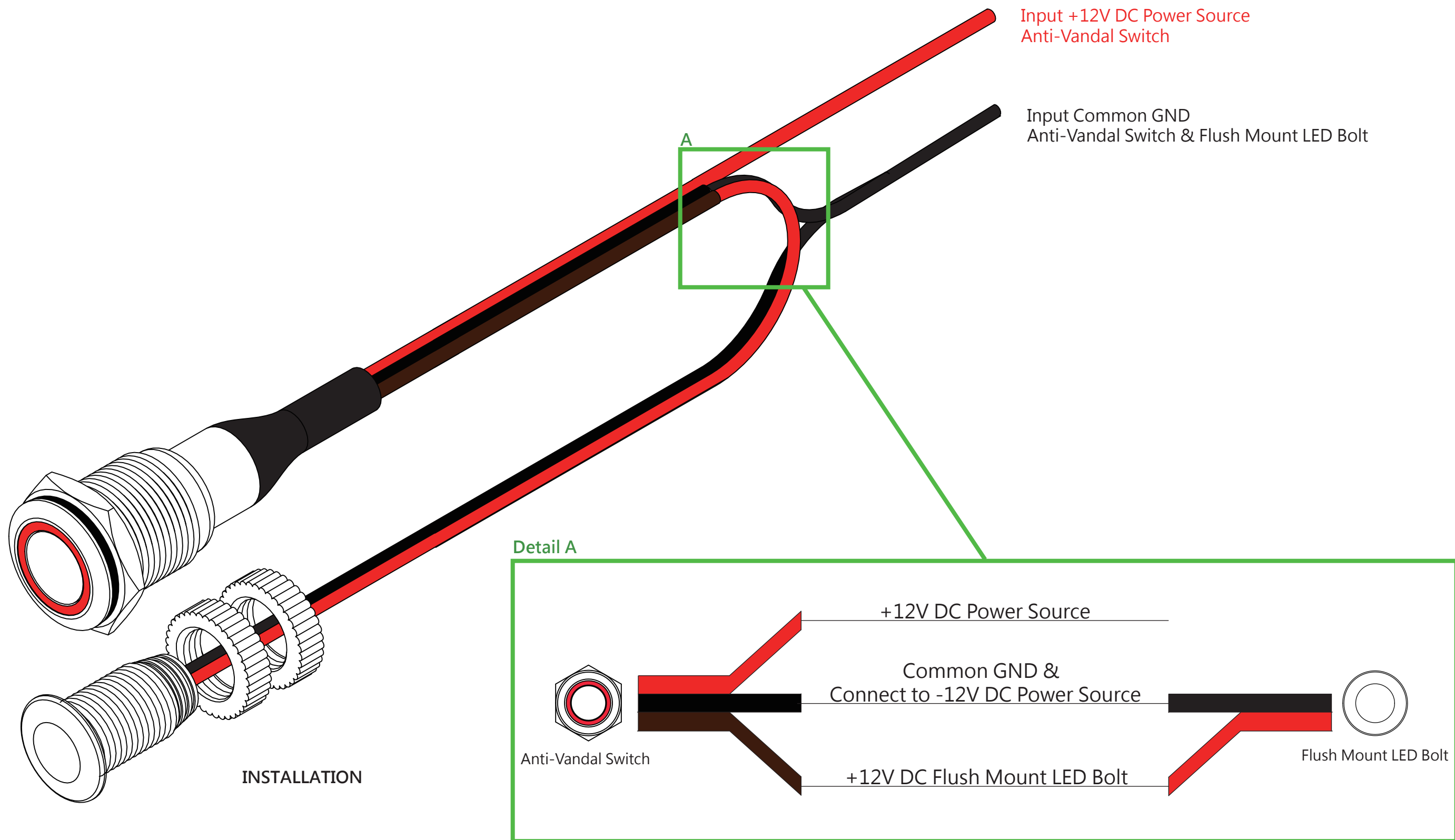

INSTALLATION

Technical Information (Per module): Operating Voltage: DC 12V Maximum Current Load: 3A		 AtomicTiger	
		VERSION:	
PRODUCT NUMBER: 371	REVISION: A	PAGE: 3 of 3	